



16-Bit, Parallel Input Multiplying Digital-to-Analog Converter

FEATURES

- ± 0.5 LSB DNL
- ± 1 LSB INL
- 16-Bit Monotonic
- Low Noise: $10 \text{ nV}/\sqrt{\text{Hz}}$
- Low Power: $I_{DD} = 2 \mu\text{A}$
- Analog Power Supply: $+2.7 \text{ V}$ to $+5.5 \text{ V}$
- 1.66 mA Full-Scale Current, with $V_{REF} = 10 \text{ V}$
- Settling Time: $0.5 \mu\text{s}$
- 4-Quadrant Multiplying Reference
- Reference Bandwidth: 8 MHz
- Reference Input: $\pm 15 \text{ V}$
- Reference Dynamics: -105 dB THD
- SSOP-28 Package
- Industry-Standard Pin Configuration

APPLICATIONS

- Automatic Test Equipment
- Instrumentation
- Digitally Controlled Calibration
- Industrial Control PLCs

DESCRIPTION

The DAC8820, a multiplying digital-to-analog converter (DAC), is designed to operate from a single 2.7 V to 5.5 V supply.

The applied external reference input voltage V_{REF} determines the full-scale output current. An internal feedback resistor (R_{FB}) provides temperature tracking for the full-scale output when combined with an external, current-to-voltage (I/V) precision amplifier.

A parallel interface offers high-speed communications. The DAC8820 is packaged in a space-saving SSOP-28 package and has an industry-standard pinout.

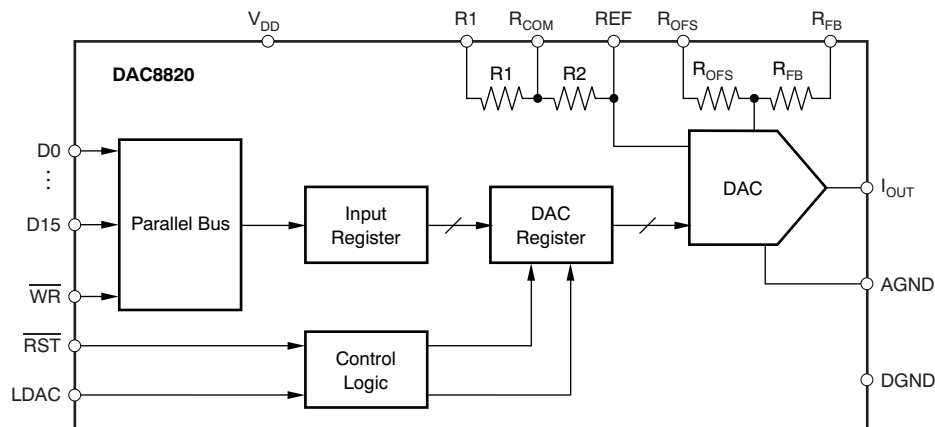

Please be aware that an important notice concerning availability, standard warranty, and use in critical applications of Texas Instruments semiconductor products and disclaimers thereto appears at the end of this data sheet.

All trademarks are the property of their respective owners.



This integrated circuit can be damaged by ESD. Texas Instruments recommends that all integrated circuits be handled with appropriate precautions. Failure to observe proper handling and installation procedures can cause damage.

ESD damage can range from subtle performance degradation to complete device failure. Precision integrated circuits may be more susceptible to damage because very small parametric changes could cause the device not to meet its published specifications.

ORDERING INFORMATION⁽¹⁾

PRODUCT	RELATIVE ACCURACY (LSB)	DIFFERENTIAL NONLINEARITY (LSB)	PACKAGE-LEAD (DESIGNATOR)	SPECIFIED TEMPERATURE RANGE	PACKAGE MARKING	ORDERING NUMBER	TRANSPORT MEDIA, QUANTITY
DAC8820IB	±2	±1	DB-28 (SSOP)	–40°C to +85°C	DAC8820	DAC8820IBDB	Tubes, 48
						DAC8820IBDBR	Tape and Reel, 2000
DAC8820IC	±1	±1	DB-28 (SSOP)	–40°C to +85°C	DAC8820	DAC8820ICDB	Tubes, 48
						DAC8820ICDBR	Tape and Reel, 2000

(1) For the most current package and ordering information see the Package Option Addendum at the end of this document, or see the TI web site at www.ti.com.

ABSOLUTE MAXIMUM RATINGS⁽¹⁾

Over operating free-air temperature range (unless otherwise noted)

	DAC8820	UNIT
V _{DD} to GND	–0.3 to +7	V
Digital input voltage to GND	–0.3 to +V _{DD} + 0.3	V
V (I _{OUT}) to GND	–0.3 to +V _{DD} + 0.3	V
REF, R _{OFS} , R _{FB} , R1, R _{COM} to AGND, DGND	±25	V
Operating temperature range	–40 to +85	°C
Storage temperature range	–65 to +150	°C
Junction temperature range (T _J max)	+125	°C
Power dissipation	(T _J max – T _A) / R _{θJA}	W
Thermal impedance, R _{θJA}	55	°C/W
ESD rating	Human Body Model (HBM)	4000
	Charged Device Model (CDM)	1000

(1) Stresses above those listed under absolute maximum ratings may cause permanent damage to the device. Exposure to absolute maximum conditions for extended periods may affect device reliability.

ELECTRICAL CHARACTERISTICS

All specifications at -40°C to $+85^{\circ}\text{C}$, $V_{\text{DD}} = +2.7\text{ V}$ to $+5.5\text{ V}$, $I_{\text{OUT}} = \text{virtual GND}$, $\text{GND} = 0\text{ V}$, $V_{\text{REF}} = 10\text{ V}$, and $T_{\text{A}} = \text{full operating temperature}$, unless otherwise noted.

PARAMETER	CONDITIONS	DAC8820			UNITS
		MIN	TYP	MAX	
STATIC PERFORMANCE					
Resolution		16			Bits
Relative accuracy	DAC8820IB			± 2	LSB
Relative accuracy	DAC8820IC			± 1	LSB
Differential nonlinearity			± 0.5	± 1	LSB
Output leakage current	Data = 0000h, $T_{\text{A}} = +25^{\circ}\text{C}$			5	nA
Output leakage current	Data = 0000h, $T_{\text{A}} = T_{\text{MAX}}$			10	nA
Full-scale gain error	Unipolar, data = FFFFh		2	± 16	LSB
	Bipolar, data = FFFFh		2	± 16	LSB
Full-scale temperature coefficient			1	2	ppm/ $^{\circ}\text{C}$
Bipolar zero scale error	$T_{\text{A}} = +25^{\circ}\text{C}$			± 5	LSB
	$T_{\text{A}} = T_{\text{MAX}}$			± 8	LSB
PSRR	Power-supply rejection ratio; $V_{\text{DD}} = 5\text{ V} \pm 10\%$		± 0.2	± 2.0	LSB/V
OUTPUT CHARACTERISTICS⁽¹⁾					
Output current			1.66		mA
Output capacitance	Code dependent		50		pF
REFERENCE INPUT					
V_{REF} Range		-15		15	V
R_{REF}	Input resistance (unipolar)	4.5	6	7.5	k Ω
Input capacitance			5		pF
R1/R2	R1/R2 resistance (bipolar)	9	12	15	k Ω
R_{OFS} , R_{FB}	Feedback and offset resistance	9	12	15	k Ω
LOGIC INPUTS AND OUTPUT⁽¹⁾					
Input low voltage	V_{IL}	$V_{\text{DD}} = +2.7\text{ V}$		0.6	V
	V_{IL}	$V_{\text{DD}} = +5\text{ V}$		0.8	V
Input high voltage	V_{IH}	$V_{\text{DD}} = +2.7\text{ V}$	2.1		V
	V_{IH}	$V_{\text{DD}} = +5\text{ V}$	2.4		V
Input leakage current	I_{IL}		0.001	1	μA
Input capacitance	C_{IL}			8	pF
INTERFACE TIMING, $V_{\text{DD}} = +5.0\text{V}$⁽¹⁾ (See Figure 40 and Table 1)					
	t_{DS}	Data to $\overline{\text{WR}}$ setup time	20		ns
	t_{DH}	Data to $\overline{\text{WR}}$ hold time	0		ns
	t_{WR}	$\overline{\text{WR}}$ pulse width	20		ns
	t_{LDAC}	LDAC pulse width	20		ns
Data setup time	t_{RST}	$\overline{\text{RST}}$ pulse width	20		ns
Data hold time	t_{LWD}	$\overline{\text{WR}}$ to LDAC delay time	0		ns
INTERFACE TIMING, $V_{\text{DD}} = +2.7\text{V}$⁽¹⁾ (See Figure 40 and Table 1)					
	t_{DS}	Data to $\overline{\text{WR}}$ setup time	35		ns
	t_{DH}	Data to $\overline{\text{WR}}$ hold time	0		ns
	t_{WR}	$\overline{\text{WR}}$ pulse width	35		ns
	t_{LDAC}	LDAC pulse width	35		ns
Data setup time	t_{RST}	$\overline{\text{RST}}$ pulse width	35		ns
Data hold time	t_{LWD}	$\overline{\text{WR}}$ to LDAC delay time	0		ns

(1) Specified by design and characterization; not production tested.

ELECTRICAL CHARACTERISTICS (continued)

All specifications at -40°C to $+85^{\circ}\text{C}$, $V_{\text{DD}} = +2.7\text{ V}$ to $+5.5\text{ V}$, $I_{\text{OUT}} = \text{virtual GND}$, $\text{GND} = 0\text{ V}$, $V_{\text{REF}} = 10\text{ V}$, and $T_{\text{A}} = \text{full operating temperature}$, unless otherwise noted.

PARAMETER	CONDITIONS	DAC8820			UNITS
		MIN	TYP	MAX	
POWER REQUIREMENTS					
V_{DD}		2.7		5.5	V
I_{DD} (normal operation)	Logic inputs = 0 V			5	μA
$V_{\text{DD}} = +4.5\text{ V}$ to $+5.5\text{ V}$	$V_{\text{IH}} = V_{\text{DD}}$ and $V_{\text{IL}} = \text{GND}$		3	5	μA
$V_{\text{DD}} = +2.7\text{ V}$ to $+3.6\text{ V}$	$V_{\text{IH}} = V_{\text{DD}}$ and $V_{\text{IL}} = \text{GND}$		1	2.5	μA
AC CHARACTERISTICS⁽²⁾					
Output current settling time			0.5		μs
Reference multiplying BW	$V_{\text{REF}} = 5\text{ V}_{\text{PP}}$, Data = FFFFh		8		MHz
DAC glitch impulse	$V_{\text{REF}} = 0\text{ V}$ to 10 V , Data = 7FFFh to 8000h to 7FFFh		2		nV-s
Feedthrough error $V_{\text{OUT}}/V_{\text{REF}}$	Data = 0000h, $V_{\text{REF}} = 10\text{ kHz}$, $\pm 10\text{ V}_{\text{PP}}$		-70		dB
Digital feedthrough	LDAC = Logic low, $V_{\text{REF}} = -10\text{ V}$ to $+10\text{ V}$ Any code change		1		nV-s
Total harmonic distortion	$V_{\text{REF}} = 6\text{ V}_{\text{RMS}}$, Data = FFFFh, $f = 1\text{ kHz}$		-105		dB
Output spot noise voltage			10		$\text{nV}/\sqrt{\text{Hz}}$

(2) Specified by design and characterization; not production tested.

PIN ASSIGNMENTS

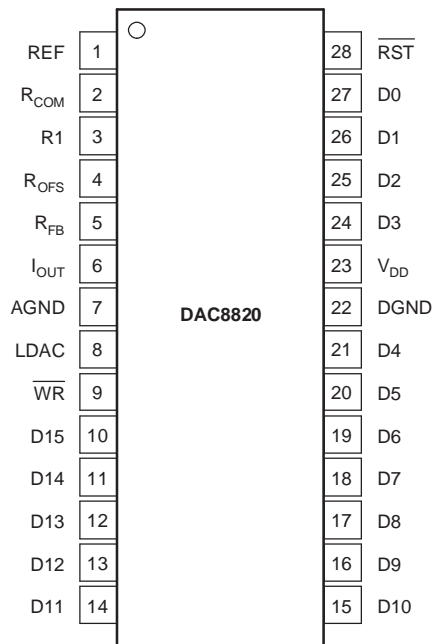

TERMINAL FUNCTIONS

PIN #	NAME	DESCRIPTION
1	REF	Reference input and 4-quadrant resistor (R2).
2	R _{COM}	Center tap of two 4-quadrant resistors (R1 and R2).
3	R1	4-quadrant resistor (R1).
4	R _{OFS}	Bipolar offset resistor
5	R _{FB}	Internal matching feedback resistor
6	I _{OUT}	DAC current output
7	AGND	Analog ground
8	LDAC	Digital input load DAC control. When LDAC is high, data is loaded from input register into a DAC register, updating the DAC output.
9	WR	Write control digital input. Active low. When WR is taken to logic low, data is loaded from the digital input pins (D0–D15) into a 16-bit input register.
10–21	D15–D4	Digital input data bits. D15 is MSB.
22	DGND	Digital ground
23	V _{DD}	Positive power supply
24–27	D3–D0	Digital Input data bits. D0 is LSB.
28	RST	Reset. Active low. When RST is taken to logic low, the DAC register is set to zero code, resulting in the DAC output being set to 0 V.

TYPICAL CHARACTERISTICS: $V_{DD} = +5\text{ V}$

At $T_A = +25^\circ\text{C}$, unless otherwise noted.

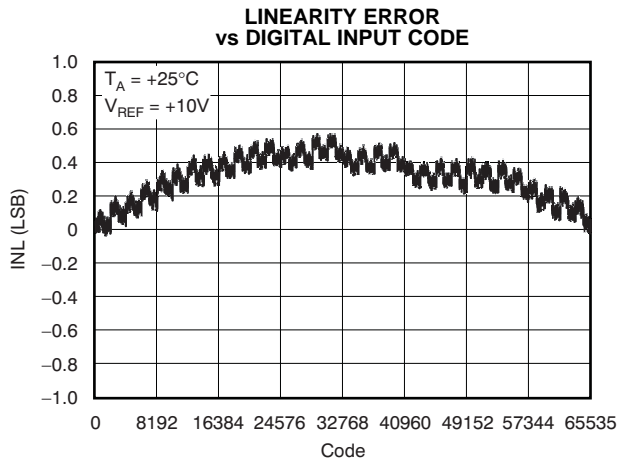

Figure 1.

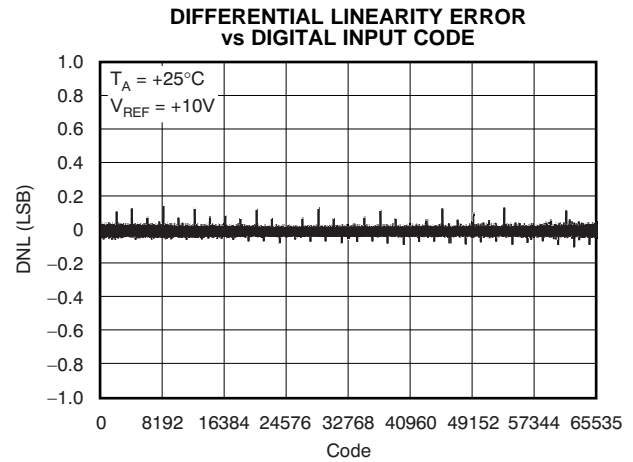

Figure 2.

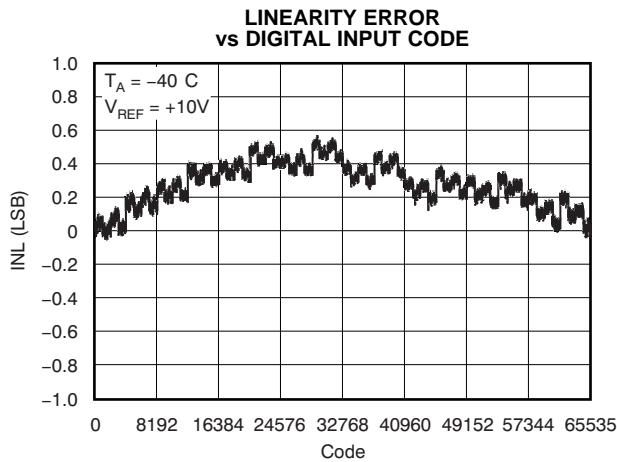

Figure 3.

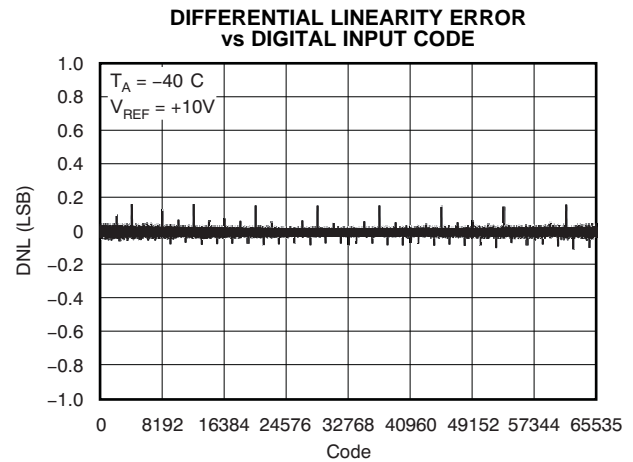

Figure 4.

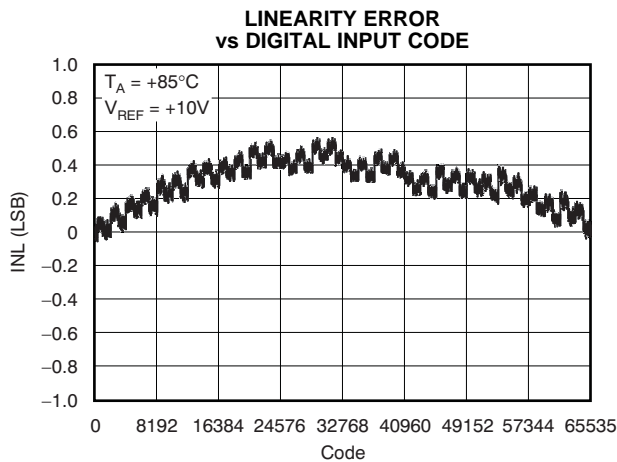

Figure 5.

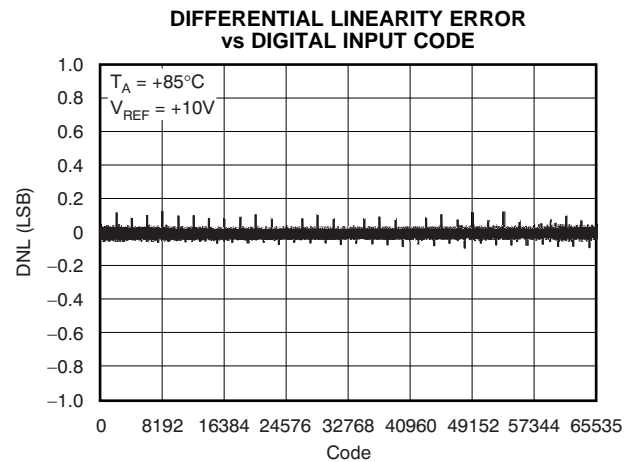

Figure 6.

TYPICAL CHARACTERISTICS: $V_{DD} = +5\text{ V}$ (continued)

At $T_A = +25^\circ\text{C}$, unless otherwise noted.

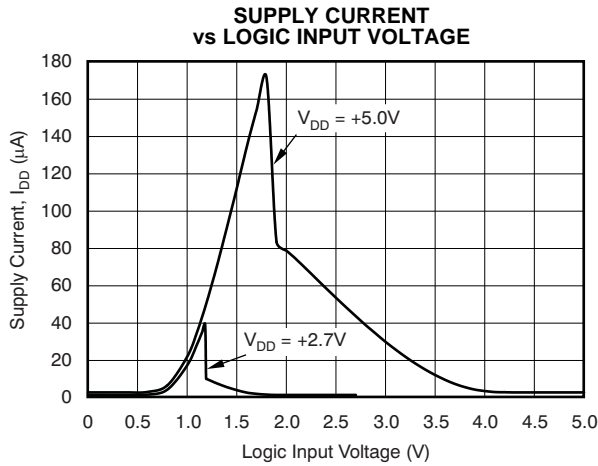

Figure 7.

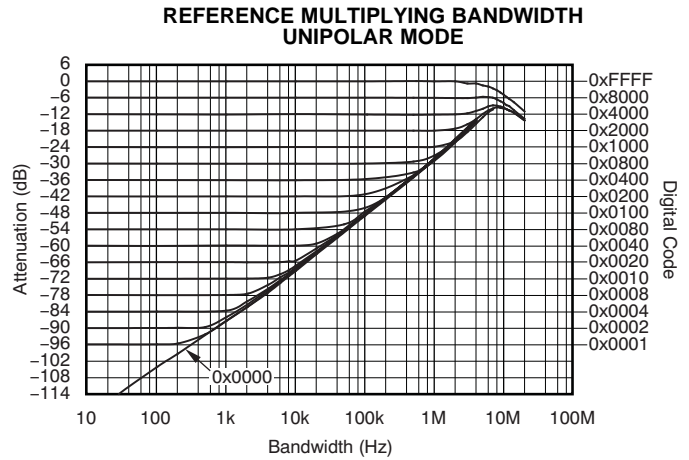

Figure 8.

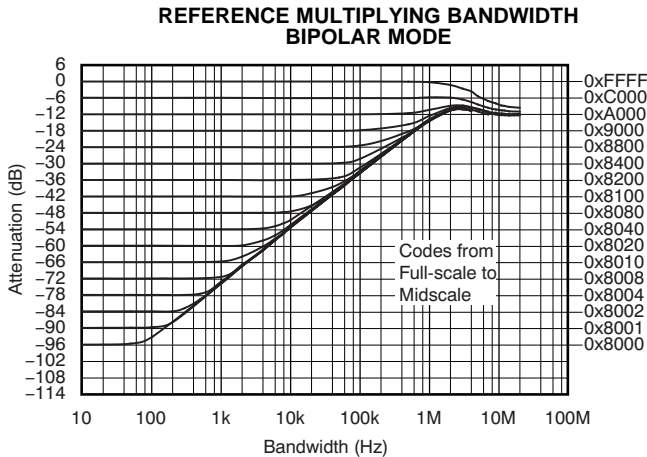

Figure 9.

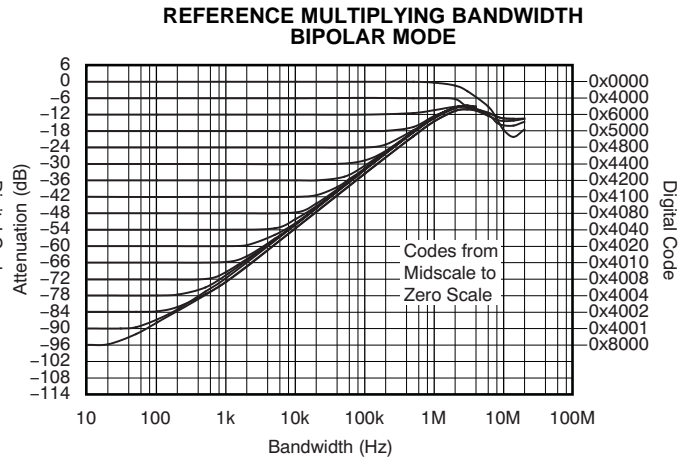

Figure 10.

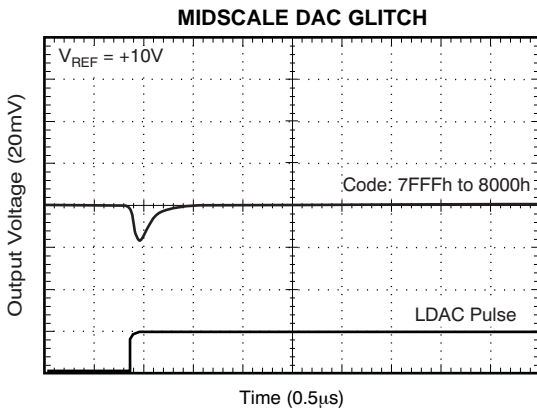

Figure 11.

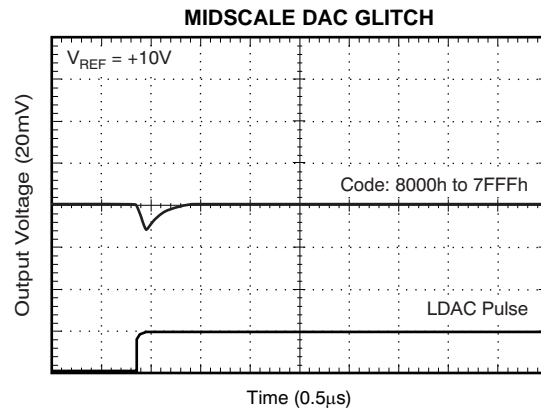

Figure 12.

TYPICAL CHARACTERISTICS: $V_{DD} = +5\text{ V}$ (continued)

At $T_A = +25^\circ\text{C}$, unless otherwise noted.

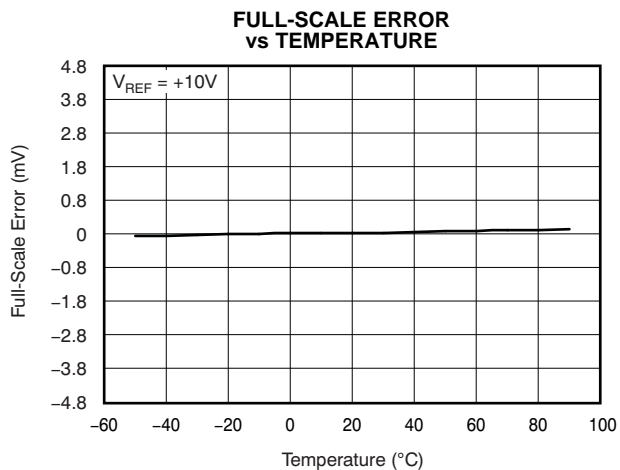

Figure 13.

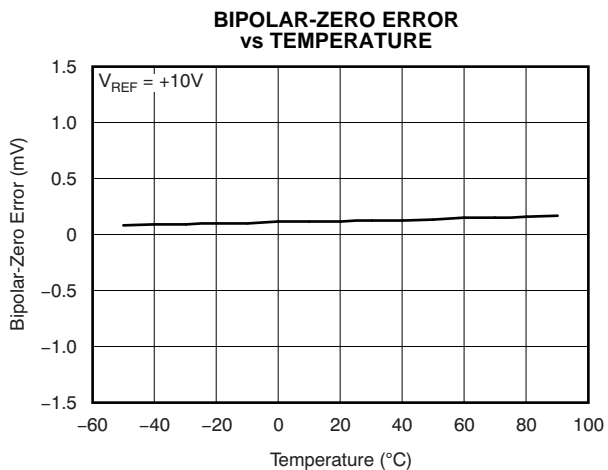

Figure 14.

TYPICAL CHARACTERISTICS: $V_{DD} = +2.7 V$

At $T_A = +25^\circ C$, unless otherwise noted.

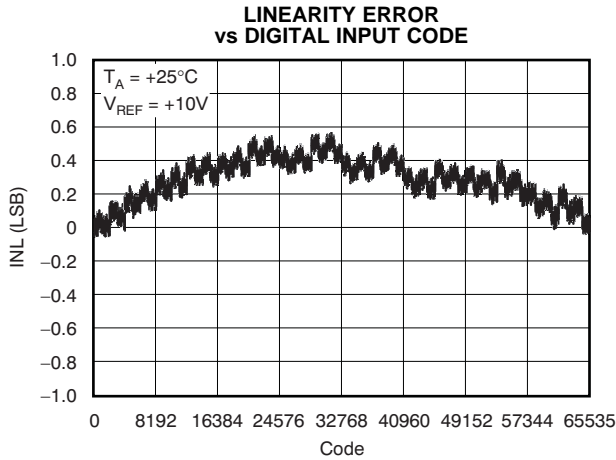

Figure 15.

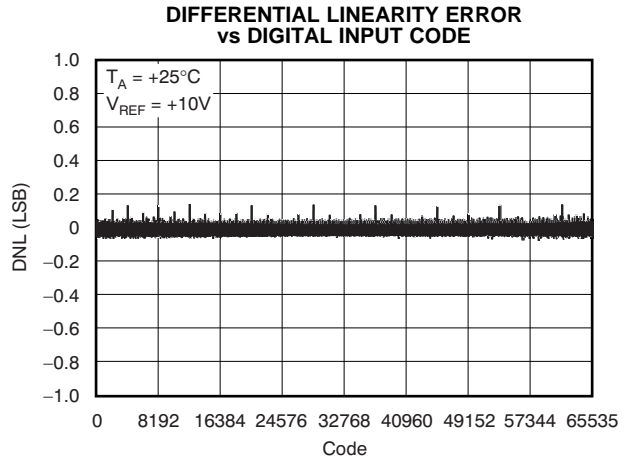

Figure 16.

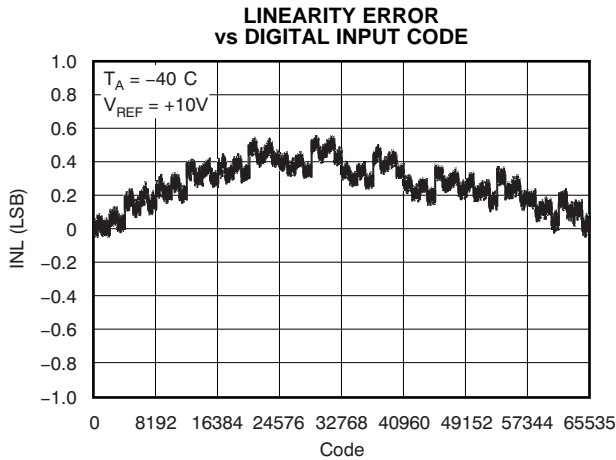

Figure 17.

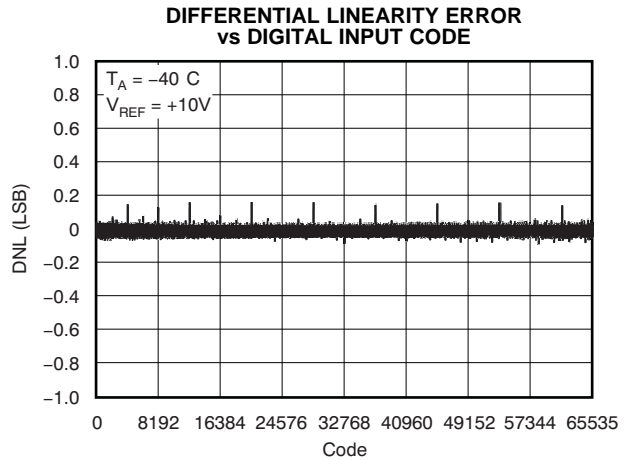

Figure 18.

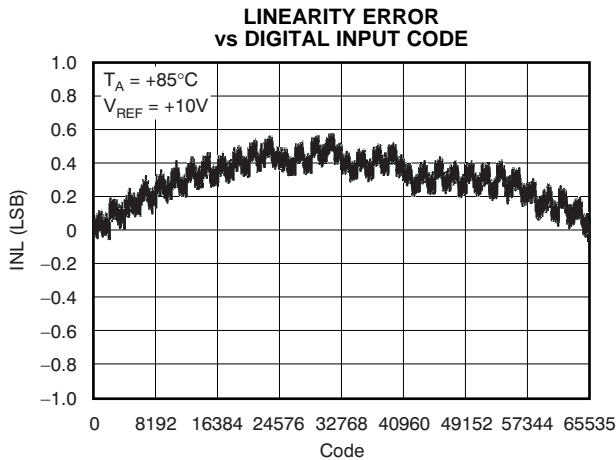

Figure 19.

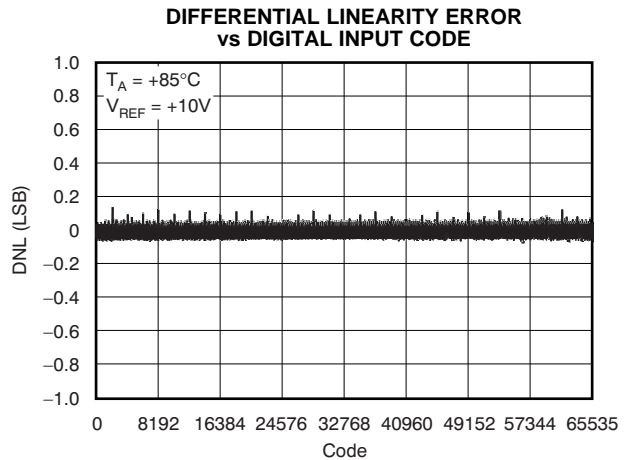

Figure 20.

TYPICAL CHARACTERISTICS: $V_{DD} = +2.7\text{ V}$ (continued)

At $T_A = +25^\circ\text{C}$, unless otherwise noted.

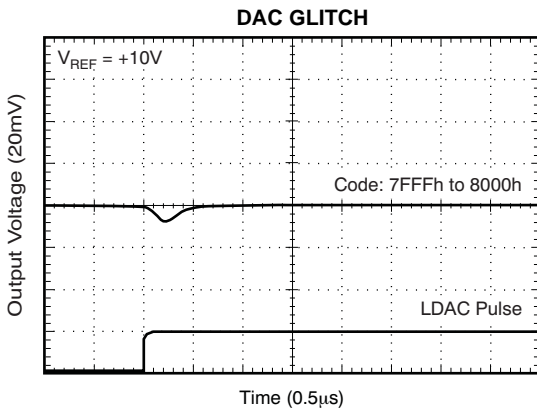

Figure 21.

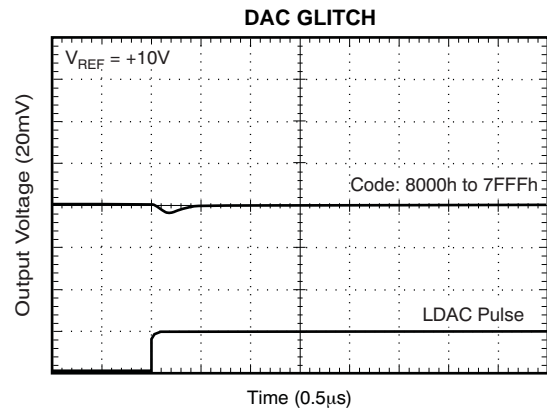

Figure 22.

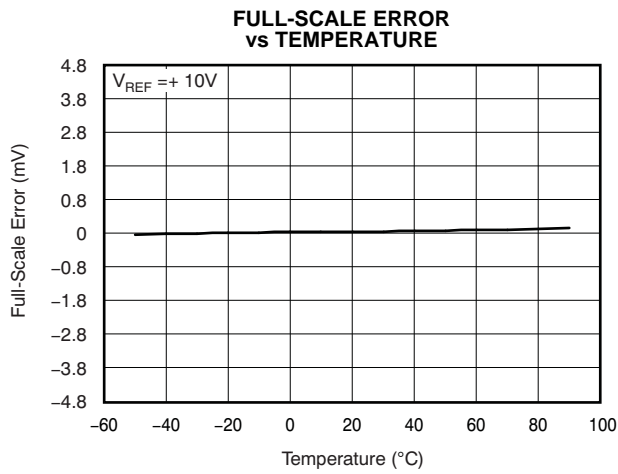

Figure 23.

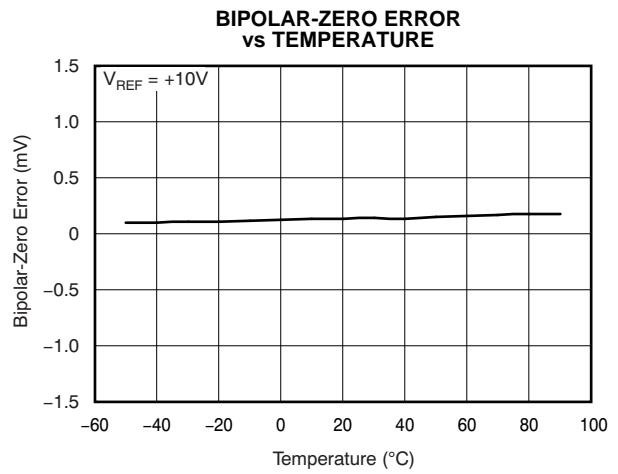

Figure 24.

TYPICAL CHARACTERISTICS

At $T_A = +25^\circ\text{C}$, unless otherwise noted.

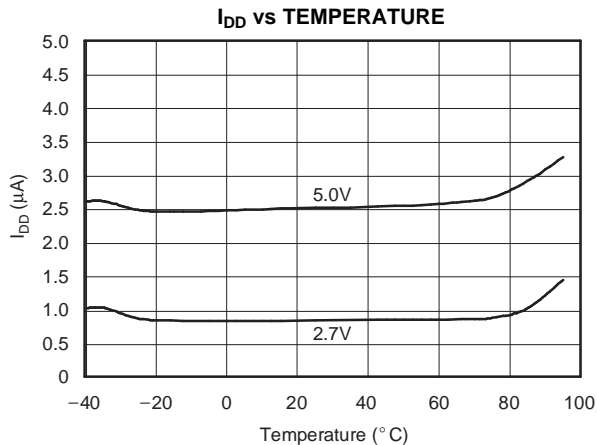

Figure 25.

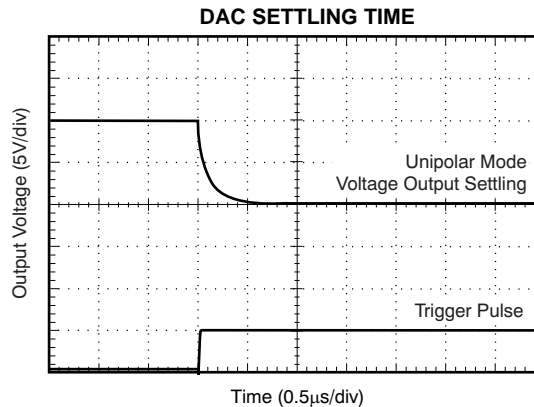

Figure 26.

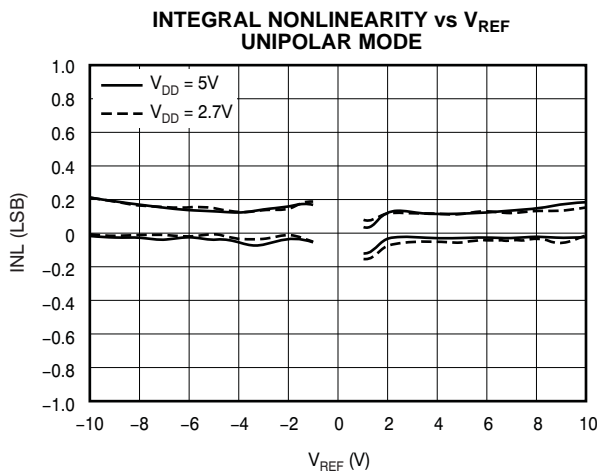

Figure 27.

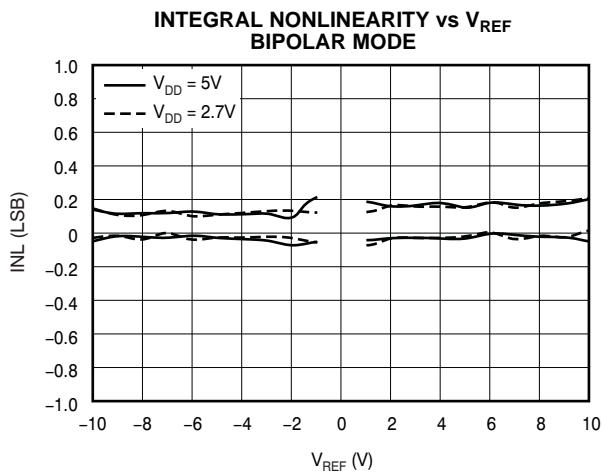

Figure 28.

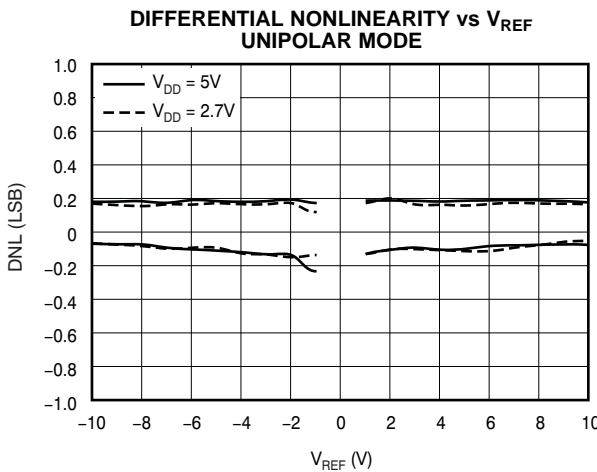

Figure 29.

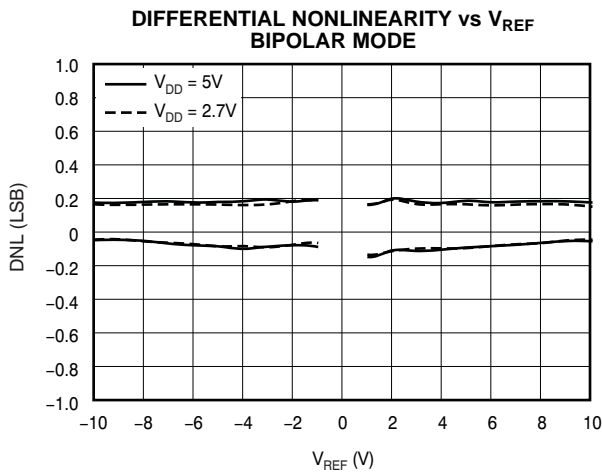

Figure 30.

TYPICAL CHARACTERISTICS (continued)

At $T_A = +25^\circ\text{C}$, unless otherwise noted.

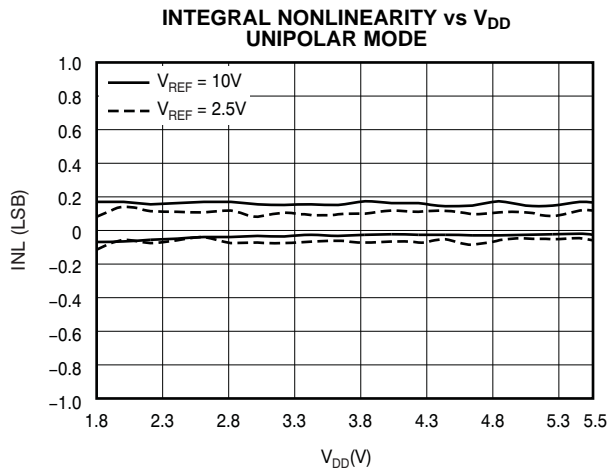

Figure 31.

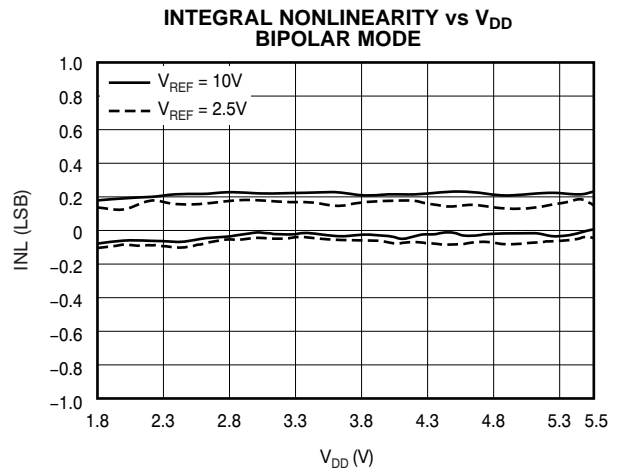

Figure 32.

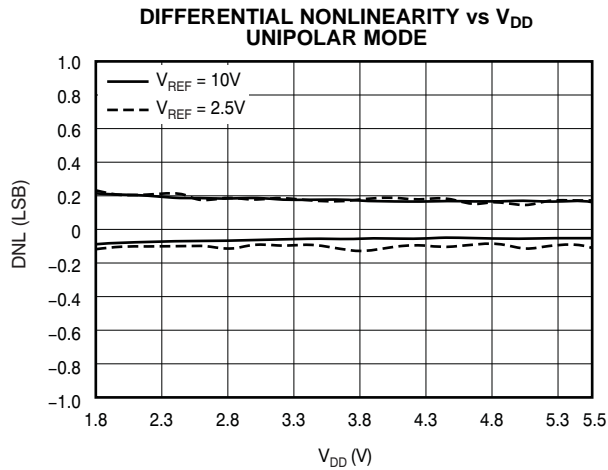

Figure 33.

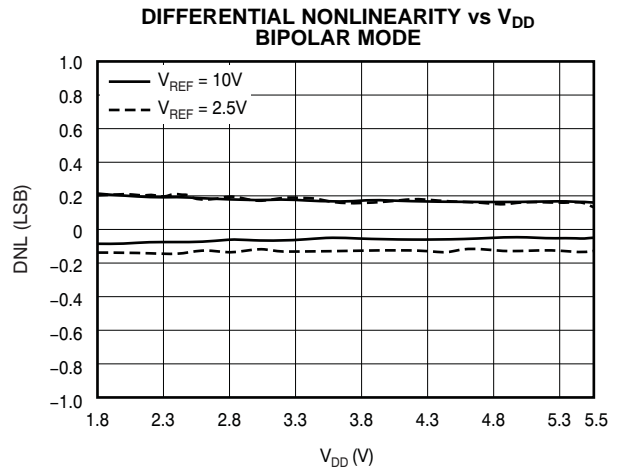

Figure 34.

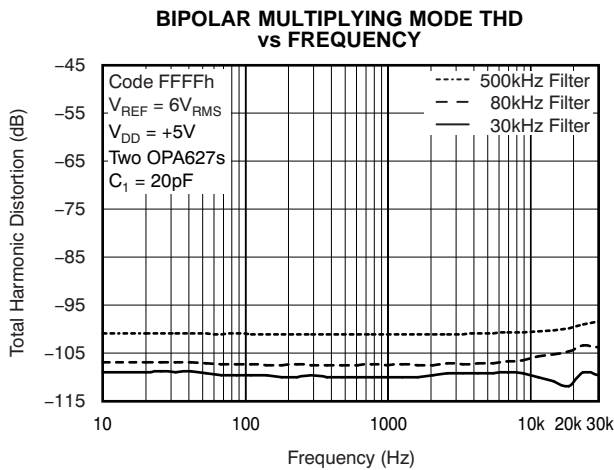

Figure 35.

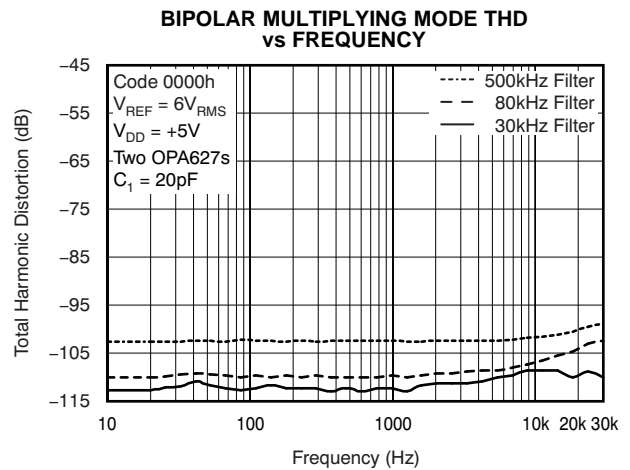

Figure 36.

TYPICAL CHARACTERISTICS (continued)

At T_A = +25°C, unless otherwise noted.

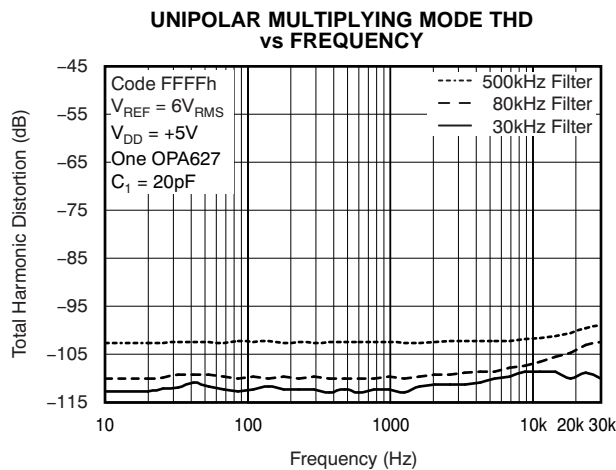

Figure 37.

THEORY OF OPERATION

The DAC8820 is a multiplying, single-channel current output, 16-bit DAC. The architecture, illustrated in Figure 38, is an R-2R ladder configuration with the three MSBs segmented. Each 2R leg of the ladder is either switched to GND or to the I_{OUT} terminal. The I_{OUT} terminal of the DAC is held at a virtual GND potential by the use of an external I/V converter op amp. The R-2R ladder is connected to an external reference input (V_{REF}) that determines the DAC full-scale current. The R-2R ladder presents a code independent load impedance to the external reference of 6 kΩ ±25%. The external reference voltage can vary in a range of –15 V to +15 V, thus providing bipolar I_{OUT} current operation. By using an external I/V converter op amp and the R_{FB} resistor in the DAC8820, an output voltage range of –V_{REF} to +V_{REF} can be generated.

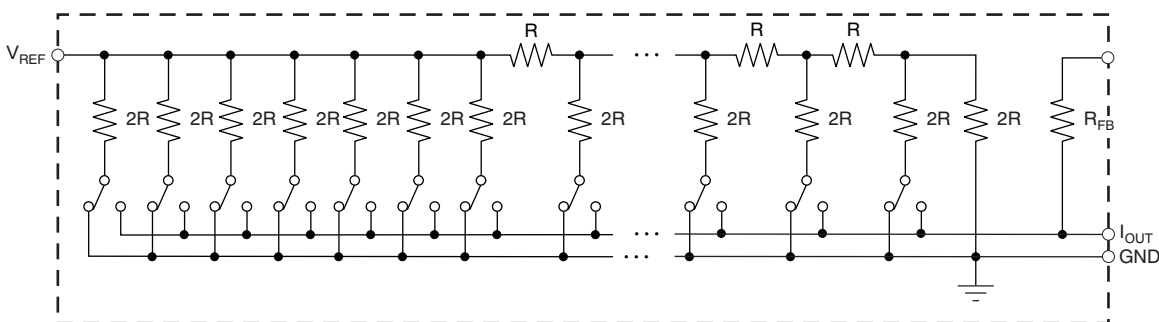

Figure 38. Equivalent R-2R DAC Circuit

The DAC output voltage is determined by V_{REF} and the digital data (D) according to Equation 1:

$$V_{OUT} = -V_{REF} \times \frac{D}{65536} \tag{1}$$

Each DAC code determines the 2R-leg switch position to either GND or I_{OUT}. The external I/V converter op amp noise gain will also change because the DAC output impedance (as seen looking into the I_{OUT} terminal) changes versus code. Because of this, the external I/V converter op amp must have a sufficiently low offset voltage such that the amplifier offset is not modulated by the DAC I_{OUT} terminal impedance change. External op amps with large offset voltages can produce INL errors in the transfer function of the DAC8820 because of offset modulation versus DAC code. For best linearity performance of the DAC8820, an op amp (OPA277) is recommended, as shown in Figure 39. This circuit allows V_{REF} to swing from –10 V to +10 V.

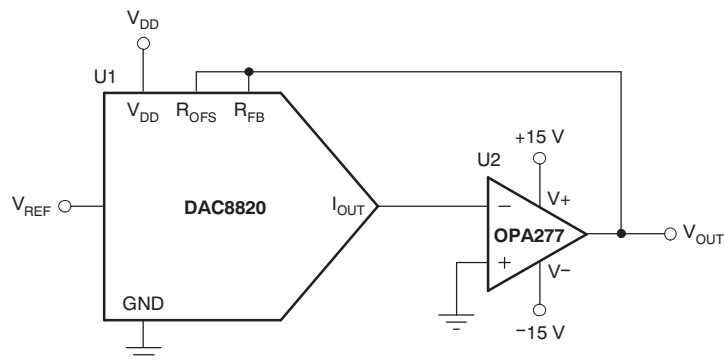

Figure 39. Voltage Output Configuration

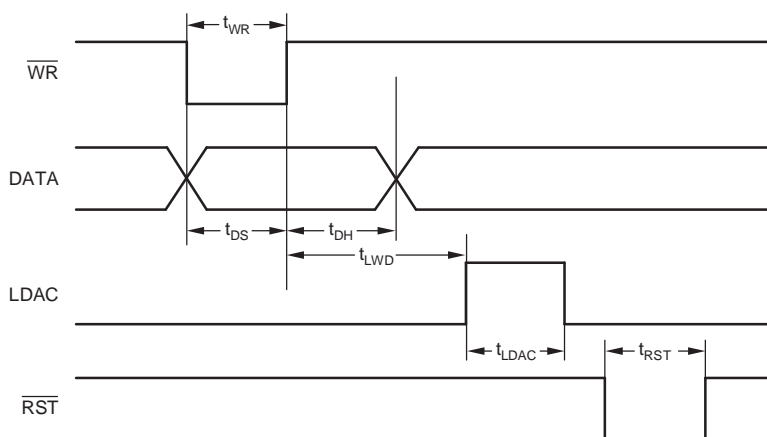



Figure 40. DAC8820 Timing Diagram

Table 1. Function of Control Inputs

CONTROL INPUTS			REGISTER OPERATION
$\overline{\text{RST}}$	$\overline{\text{WR}}$	LDAC	
0	X	X	Asynchronous operation. The DAC register is set to zero code, resulting in the DAC output being set to 0 V. The DAC input register contents are not reset by the RST signal.
1	0	0	Load the input register with all 16 data bits.
1	1	1	Load the DAC register with the contents of the input register.
1	0	1	The input and DAC register are transparent.
1			LDAC and $\overline{\text{WR}}$ are tied together and programmed as a pulse. The 16 data bits are loaded into the input register on the falling edge of the pulse and then loaded into the DAC register on the rising edge of the pulse.
1	1	0	No register operation.

APPLICATION INFORMATION

Multiplying Mode THD vs Frequency

Figure 35 and Figure 36 show the DAC8820 bipolar 4-quadrant multiplying mode total harmonic distortion (THD) versus frequency. Figure 35 shows the bipolar multiplying mode THD with the DAC8820 set to a full-scale code of FFFFh. Figure 36 shows the bipolar multiplying mode THD with the DAC8820 set to a minus full scale code of 0000h. In both graphs, two OPA627s are used for both the DAC output op amp and the reference inverting amplifier. A $6 V_{RMS}$ sine wave is used for the reference input V_{REF} and is swept in frequency from 10 Hz to 30 kHz. The THD levels versus frequency are illustrated at various DAC output filtering levels using an external ac-coupled low-pass filter.

Figure 37 illustrates the DAC8820 unipolar 2-quadrant multiplying mode THD versus frequency. The DAC8820 is set to a full-scale code of FFFFh. A single OPA627 is used for the DAC output op amp.

Stability Circuit

For a current-to-voltage (I/V) design, as shown in Figure 41, the DAC8820 current output (I_{OUT}) and the connection with the inverting node of the op amp should be as short as possible and laid out according to correct printed circuit board (PCB) layout design. For each code change there is a step function. If the gain bandwidth product (GBP) of the op amp is limited and parasitic capacitance is excessive at the inverting node, then gain peaking is possible. Therefore, a compensation capacitor C1 (4 pF to 20 pF, typ) can be added to the design for circuit stability, as shown in Figure 41.

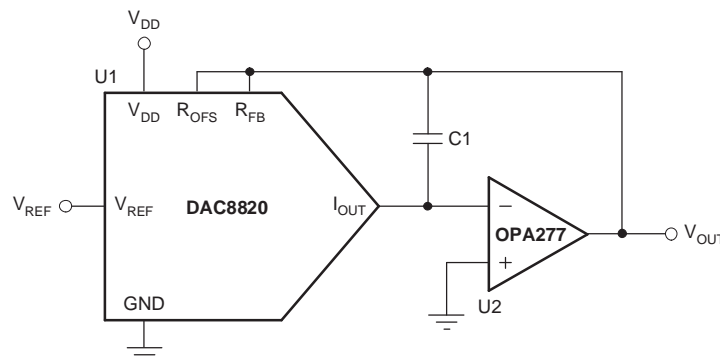

Figure 41. Gain Peaking Prevention Circuit with Compensation Capacitor

Bipolar Output Circuit

The DAC8820, as a 4-quadrant multiplying DAC, can be used to generate a bipolar output. The polarity of the full-scale output (I_{OUT}) is the inverse of the input reference voltage at V_{REF} .

Using a dual op amp, such as the OPA2277, full 4-quadrant operation can be achieved with minimal components. Figure 42 demonstrates a $\pm 10 V_{OUT}$ circuit with a fixed +10 V reference.

$$V_{OUT} = \left(\frac{D}{32,768} - 1 \right) \times V_{REF} \quad (2)$$

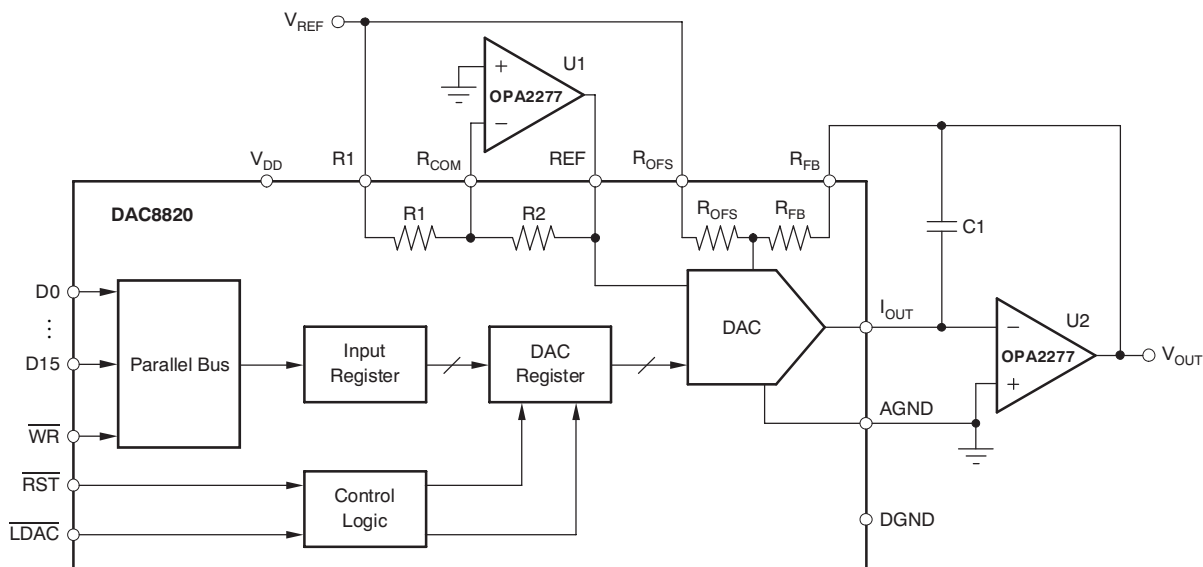

Figure 42. Bipolar Output Circuit

Programmable Current Source Circuit

A DAC8820 can be integrated into the circuit in Figure 43 to implement an improved Howland current pump for precise V/I conversions. Bidirectional current flow and high-voltage compliance are two features of the circuit. With a matched resistor network, the load current of the circuit is shown by Equation 3:

$$I_L = \frac{(R2 + R3) / R1}{R3} \times V_{REF} \times D \quad (3)$$

The value of R3 in the previous equation can be reduced to increase the output current drive of U3. U3 can drive ± 20 mA in both directions with voltage compliance limited up to 15 V by the U3 voltage supply. Elimination of the circuit compensation capacitor (C1) in the circuit is not suggested as a result of the change in the output impedance (Z_O), according to Equation 4:

$$Z_O = \frac{R1'R3(R1 + R2)}{R1(R2' + R3') - R1'(R2 + R3)} \quad (4)$$

As shown in Equation 4, Z_O with matched resistors is infinite and the circuit is optimum for use as a current source. However, if unmatched resistors are used, Z_O is positive or negative with negative output impedance being a potential cause of oscillation. Therefore, by incorporating C1 into the circuit, possible oscillation problems are eliminated. The value of C1 can be determined for critical applications; for most applications, however, a value of several pF is suggested.

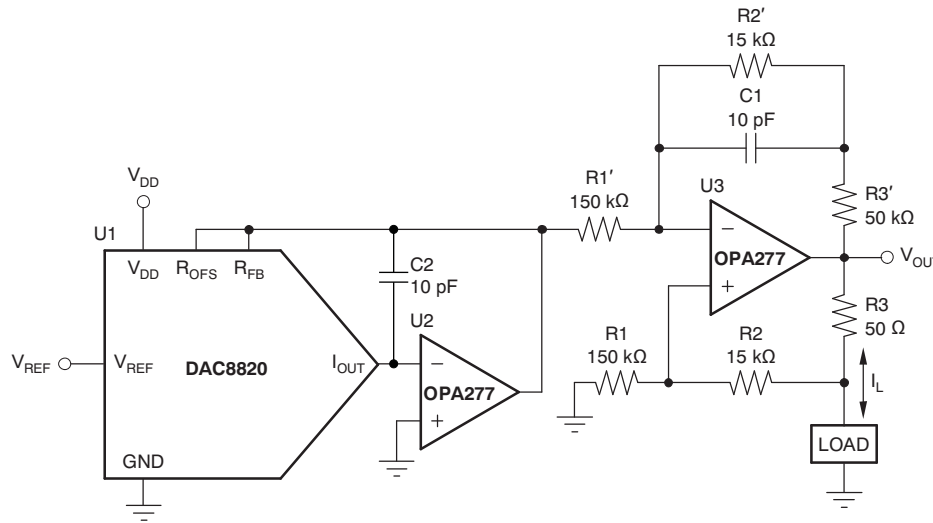

Figure 43. Programmable Bidirectional Current Source Circuit

Cross-Reference

The DAC8820 has an industry-standard pinout. [Table 2](#) provides the cross-reference information.

Table 2. Cross-Reference

PRODUCT	BIT	INL (LSB)	DNL (LSB)	SPECIFIED TEMPERATURE RANGE	PACKAGE DESCRIPTION	PACKAGE OPTION	CROSS-REFERENCE PART
DAC8820IBDB	16	±2	±1	-40°C to +85°C	SSOP-28	SSOP-28	LTC1597BIG
DAC8820ICDB	16	±1	±1	-40°C to +85°C	SSOP-28	SSOP-28	LTC1597AIG

Revision History

NOTE: Page numbers for previous revisions may differ from page numbers in the current version.

Changes from Revision C (June 2006) to Revision D	Page
• Changed front page block diagram.....	1
• Changed pin 28 description text in <i>Terminal Functions</i> table.....	4
• Changed first row description text in Table 1	13
• Changed Figure 42	15

Changes from Revision B (March 2006) to Revision C	Page
• Changed from "voltage-to-current" to "current-to-voltage".....	1
• Added bipolar zero scale error specification.....	3

PACKAGING INFORMATION

Orderable Device	Status ⁽¹⁾	Package Type	Package Drawing	Pins	Package Qty	Eco Plan ⁽²⁾	Lead/Ball Finish	MSL Peak Temp ⁽³⁾
DAC8820IBDB	ACTIVE	SSOP	DB	28	50	Green (RoHS & no Sb/Br)	CU NIPDAU	Level-2-260C-1 YEAR
DAC8820IBDBG4	ACTIVE	SSOP	DB	28	50	Green (RoHS & no Sb/Br)	CU NIPDAU	Level-2-260C-1 YEAR
DAC8820IBDBR	ACTIVE	SSOP	DB	28	2000	Green (RoHS & no Sb/Br)	CU NIPDAU	Level-2-260C-1 YEAR
DAC8820IBDBRG4	ACTIVE	SSOP	DB	28	2000	Green (RoHS & no Sb/Br)	CU NIPDAU	Level-2-260C-1 YEAR
DAC8820ICDB	ACTIVE	SSOP	DB	28	50	Green (RoHS & no Sb/Br)	CU NIPDAU	Level-2-260C-1 YEAR
DAC8820ICDBG4	ACTIVE	SSOP	DB	28	50	Green (RoHS & no Sb/Br)	CU NIPDAU	Level-2-260C-1 YEAR
DAC8820ICDBR	ACTIVE	SSOP	DB	28	2000	Green (RoHS & no Sb/Br)	CU NIPDAU	Level-2-260C-1 YEAR
DAC8820ICDBRG4	ACTIVE	SSOP	DB	28	2000	Green (RoHS & no Sb/Br)	CU NIPDAU	Level-2-260C-1 YEAR

⁽¹⁾ The marketing status values are defined as follows:

ACTIVE: Product device recommended for new designs.

LIFEBUY: TI has announced that the device will be discontinued, and a lifetime-buy period is in effect.

NRND: Not recommended for new designs. Device is in production to support existing customers, but TI does not recommend using this part in a new design.

PREVIEW: Device has been announced but is not in production. Samples may or may not be available.

OBSOLETE: TI has discontinued the production of the device.

⁽²⁾ Eco Plan - The planned eco-friendly classification: Pb-Free (RoHS), Pb-Free (RoHS Exempt), or Green (RoHS & no Sb/Br) - please check <http://www.ti.com/productcontent> for the latest availability information and additional product content details.

TBD: The Pb-Free/Green conversion plan has not been defined.

Pb-Free (RoHS): TI's terms "Lead-Free" or "Pb-Free" mean semiconductor products that are compatible with the current RoHS requirements for all 6 substances, including the requirement that lead not exceed 0.1% by weight in homogeneous materials. Where designed to be soldered at high temperatures, TI Pb-Free products are suitable for use in specified lead-free processes.

Pb-Free (RoHS Exempt): This component has a RoHS exemption for either 1) lead-based flip-chip solder bumps used between the die and package, or 2) lead-based die adhesive used between the die and leadframe. The component is otherwise considered Pb-Free (RoHS compatible) as defined above.

Green (RoHS & no Sb/Br): TI defines "Green" to mean Pb-Free (RoHS compatible), and free of Bromine (Br) and Antimony (Sb) based flame retardants (Br or Sb do not exceed 0.1% by weight in homogeneous material)

⁽³⁾ MSL, Peak Temp. -- The Moisture Sensitivity Level rating according to the JEDEC industry standard classifications, and peak solder temperature.

Important Information and Disclaimer:The information provided on this page represents TI's knowledge and belief as of the date that it is provided. TI bases its knowledge and belief on information provided by third parties, and makes no representation or warranty as to the accuracy of such information. Efforts are underway to better integrate information from third parties. TI has taken and continues to take reasonable steps to provide representative and accurate information but may not have conducted destructive testing or chemical analysis on incoming materials and chemicals. TI and TI suppliers consider certain information to be proprietary, and thus CAS numbers and other limited information may not be available for release.

In no event shall TI's liability arising out of such information exceed the total purchase price of the TI part(s) at issue in this document sold by TI to Customer on an annual basis.

TAPE AND REEL INFORMATION



QUADRANT ASSIGNMENTS FOR PIN 1 ORIENTATION IN TAPE



*All dimensions are nominal

Device	Package Type	Package Drawing	Pins	SPQ	Reel Diameter (mm)	Reel Width W1 (mm)	A0 (mm)	B0 (mm)	K0 (mm)	P1 (mm)	W (mm)	Pin1 Quadrant
DAC8820IBDBR	SSOP	DB	28	2000	330.0	16.4	8.1	10.4	2.5	12.0	16.0	Q1
DAC8820ICDBR	SSOP	DB	28	2000	330.0	16.4	8.1	10.4	2.5	12.0	16.0	Q1

TAPE AND REEL BOX DIMENSIONS



*All dimensions are nominal

Device	Package Type	Package Drawing	Pins	SPQ	Length (mm)	Width (mm)	Height (mm)
DAC8820IBDBR	SSOP	DB	28	2000	346.0	346.0	33.0
DAC8820ICDBR	SSOP	DB	28	2000	346.0	346.0	33.0

IMPORTANT NOTICE

Texas Instruments Incorporated and its subsidiaries (TI) reserve the right to make corrections, modifications, enhancements, improvements, and other changes to its products and services at any time and to discontinue any product or service without notice. Customers should obtain the latest relevant information before placing orders and should verify that such information is current and complete. All products are sold subject to TI's terms and conditions of sale supplied at the time of order acknowledgment.

TI warrants performance of its hardware products to the specifications applicable at the time of sale in accordance with TI's standard warranty. Testing and other quality control techniques are used to the extent TI deems necessary to support this warranty. Except where mandated by government requirements, testing of all parameters of each product is not necessarily performed.

TI assumes no liability for applications assistance or customer product design. Customers are responsible for their products and applications using TI components. To minimize the risks associated with customer products and applications, customers should provide adequate design and operating safeguards.

TI does not warrant or represent that any license, either express or implied, is granted under any TI patent right, copyright, mask work right, or other TI intellectual property right relating to any combination, machine, or process in which TI products or services are used. Information published by TI regarding third-party products or services does not constitute a license from TI to use such products or services or a warranty or endorsement thereof. Use of such information may require a license from a third party under the patents or other intellectual property of the third party, or a license from TI under the patents or other intellectual property of TI.

Reproduction of TI information in TI data books or data sheets is permissible only if reproduction is without alteration and is accompanied by all associated warranties, conditions, limitations, and notices. Reproduction of this information with alteration is an unfair and deceptive business practice. TI is not responsible or liable for such altered documentation. Information of third parties may be subject to additional restrictions.

Resale of TI products or services with statements different from or beyond the parameters stated by TI for that product or service voids all express and any implied warranties for the associated TI product or service and is an unfair and deceptive business practice. TI is not responsible or liable for any such statements.

TI products are not authorized for use in safety-critical applications (such as life support) where a failure of the TI product would reasonably be expected to cause severe personal injury or death, unless officers of the parties have executed an agreement specifically governing such use. Buyers represent that they have all necessary expertise in the safety and regulatory ramifications of their applications, and acknowledge and agree that they are solely responsible for all legal, regulatory and safety-related requirements concerning their products and any use of TI products in such safety-critical applications, notwithstanding any applications-related information or support that may be provided by TI. Further, Buyers must fully indemnify TI and its representatives against any damages arising out of the use of TI products in such safety-critical applications.

TI products are neither designed nor intended for use in military/aerospace applications or environments unless the TI products are specifically designated by TI as military-grade or "enhanced plastic." Only products designated by TI as military-grade meet military specifications. Buyers acknowledge and agree that any such use of TI products which TI has not designated as military-grade is solely at the Buyer's risk, and that they are solely responsible for compliance with all legal and regulatory requirements in connection with such use.

TI products are neither designed nor intended for use in automotive applications or environments unless the specific TI products are designated by TI as compliant with ISO/TS 16949 requirements. Buyers acknowledge and agree that, if they use any non-designated products in automotive applications, TI will not be responsible for any failure to meet such requirements.

Following are URLs where you can obtain information on other Texas Instruments products and application solutions:

Products

Amplifiers	amplifier.ti.com
Data Converters	dataconverter.ti.com
DSP	dsp.ti.com
Clocks and Timers	www.ti.com/clocks
Interface	interface.ti.com
Logic	logic.ti.com
Power Mgmt	power.ti.com
Microcontrollers	microcontroller.ti.com
RFID	www.ti-rfid.com
RF/IF and ZigBee® Solutions	www.ti.com/lprf

Applications

Audio	www.ti.com/audio
Automotive	www.ti.com/automotive
Broadband	www.ti.com/broadband
Digital Control	www.ti.com/digitalcontrol
Medical	www.ti.com/medical
Military	www.ti.com/military
Optical Networking	www.ti.com/opticalnetwork
Security	www.ti.com/security
Telephony	www.ti.com/telephony
Video & Imaging	www.ti.com/video
Wireless	www.ti.com/wireless

Mailing Address: Texas Instruments, Post Office Box 655303, Dallas, Texas 75265
Copyright © 2008, Texas Instruments Incorporated